

Date 4/11/2022

PLANNING BOARD
VILLAGE OF ARDSLEY
507 ASHFORD AVENUE
ARDSLEY, NEW YORK 10502

APPLICATION FOR PLANNING BOARD: EXCESS HOUSE SIZE PERMIT
EXCESS LAND COVERAGE PERMIT

OWNERSHIP DATA: TO BE FILLED IN BY THE APPLICANT.

CHECK APPROPRIATE CATEGORY:

APPLICANT, IF OTHER THAN OWNER: ROSS AND AMANDA FIRSENBAUM

ROSS AND AMANDA FIRSENBAUM
OWNER=S NAME _____ APPLICANT=S NAME _____

ADDRESS 38 WESTERN DRIVE ADDRESS _____
ARDSLEY, NY 10502

PHONE NO. 646-596-0699 PHONE NO. _____

EMAIL amanda.firsenbaum@gmail.com EMAIL _____

B. PROJECT DATA:

SECTION 6.50 SUBSECTION _____ BLOCK 31 LOT(S) 7

ACREAGE .51 Acres SQUARE FEET 22,216 sf

ARCHITECT/ENGINEER SUSAN JAINCHILL, RLA ADDRESS 90 N. BROADWAY, SUITE 223, IRVINGTON
ASPECT 120 LANDSCAPE ARCHITECTURE P.C.

PHONE NO. 914-274-8544 FAX NO. _____ LICENSE NO. 001629-01

EMAIL ADDRESS: sjainchill@aspect120.com

BRIEFLY DESCRIBE THE PURPOSE OF THIS APPLICATION

The ZBA granted a variance from strict application of the requirement that the gross land coverage. The homeowners are submitting this application for a special permit for excess land coverage based on hardship due to special circumstance of the property at 38 Western Drive.

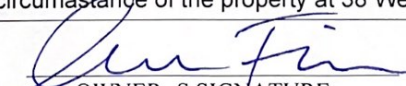
OWNER=S SIGNATURE

APPLICANT=S SIGNATURE
(IF OTHER THAN OWNER)

Susna Jainchill, RLA



Michael Wiskind, Chairman
Zoning Board of Appeals
Village of Ardsley
507 Ashford Avenue
Ardsley, NY 10502

February 7, 2022

Re: Variance Application, Building Permit Application (#2022-001)

Dear Chairman Wiskind and Board Members,

The owners of 38 Western Drive, Ross and Amanda Firsenbaum ('Applicants'), have received a denial in response to their Building Permit Application (#2022-001) to construct decks, patios, and outdoor kitchen and related site work. Based on Mr. Tomasso's denial letter dated January 20, 2022, in order for a permit to be granted, the proposed improvements would require a variance from Section 200 -10. A, B, and C, Section 200-9 and Section 200-83 of the Village of Ardsley Zoning Code. Based on the revised (corrected) dimensions the side setback would not require a variance (200-10.B). However, we are requesting a variance for Section 200-9 for excess building coverage (which was not included in the denial letter due to our misunderstanding of the code) .

With this application, the homeowners are requesting that the Zoning Board of Appeals grant variances to the following Sections of the Village of Ardsley Zoning Code: Section 200 -10, A, B, and C, Section 200-9 and Section 200-83. Three signed and notarized Application for Variance forms are included. **The basis for the variance request is hardship due to the fact that lot is substandard for the R-1 Zone.** If granted, the requested variances would allow modest improvements to the outdoor area of the property for the family's enjoyment, would improve stormwater management on the property and would not have an adverse visual impact from off-site locations.

Basis for requests

The basis for the requested for variances is hardship related to the fact that that the subject property is **substandard size in Zone R-1**. It is also **unusual in its shape and awkwardly located in relation to the street** .

- 1) The 22,216-sf property is **undersized** for the R-1 Zone which has a required area of 40,000-sf.
- 2) The lot is **atypical** in that the long edge of the rectangle form the 'front' and 'rear' property lines and the short edges of the rectangle form the side property lines. As illustrated on Sheet SK-1, the existing house infringes on the allowed yard setbacks for the R-1 Zone.
- 3) The property is located at a curve in the roadway where the public right-of way does not follow the arc of the curb line. The geometry of the right-of-way at the frontage of 38 Western Drive is unique along this street and within Ardsley. The front property line falls at an angle of approximately 30 degrees to the street curb. This forms a triangle-shaped piece of land of approximately 9000 sf within the public right-of-way, located between the front property line and the curb line. The character of this area is sloped and vegetated with large deciduous trees and lawn. This **unique situation** gives the property

the appearance that it is larger than it is. This extended area of right-of-way, which is undeveloped and undevelopable, is maintained by the Applicants.

Scope of Proposed Improvements:

The planned improvements are modest and are suitable in character and scale to the surrounding residential development. The proposed design plans shown on the attached drawing sheets include a 750-sf bluestone patio area, a 277-sf wood rear deck flush to the existing ground level, and a 259-sf wood side deck at less than 18" above existing ground level. The walkway leading from the driveway to the front door is to be realigned and a new bluestone path leading from the front door to the new patio installed on existing grade. An outdoor kitchen and new gas firepit are also included in the scope of the proposed work. A rain garden (see SK-3) will be created near the low point of the property outside the basement door to address existing sogginess and to manage additional runoff from the new hard surfaces.

Proposed improvements' additional infringement on yard setbacks:

- **Front Yard:** The existing front setback is measured from the southeast corner of the house to the property line is 26.8'. The proposed deck on the north side of the house will result in additional infringement into the front yard area. Measured from the closest point of the proposed wood deck, the proposed front setback would be 22.5' from the property line and approximately 100' from the street line. Of the proposed side wood 'deck', a 52-sf area would extend beyond the current front setback. It should be noted that this deck would be less than 18" above existing grade.
- **Rear Yard (west):** Approx. 170-sf of the proposed rear wood 'deck' on grade would extend an additional 7.5' into the rear yard. The new setback would be 29' from the rear property line.
- **North Side Yard:** The northeast corner of the existing house is 41.67' from the side lot line. The proposed side deck is 30.83' from the side lot line at its nearest point and therefore would comply with the requirements of the code. Based on these measurements no variance will be required for the side yard setback.

(In addition to drafted drawing sheets, we have included an illustrative 'Conceptual Landscape Master Plan' to demonstrate the overall vision as well as the reduction in scope and scale from our original design to what is now proposed.)

Explanation of Discrepancies

The dimensions and areas called out in this statement and the accompanying drawings and zoning worksheet reflect our current understanding of the code based on recent discussions with the Building Inspector. The following paragraph is included as an explanation of the discrepancies between the denial letter dated 1/20/2022 (which was based on material submitted 1/14/2022) and the Variance Application material being submitted 2/6/2022.

- **Front Yard and Side Yard Dimensions:** The existing side setback dimension is not shown on the 2016 property survey. A dimension of 28.1' from the northeast corner of the house to the front property line is shown on the survey. The Landscape Architect erroneously assumed this dimension to be considered the 'site yard' setback when completing the original zoning worksheet that was submitted as part of the building permit application. A revised zoning worksheet which reflects the current understanding of the code is included as part of this variance application.
- **Building Coverage:** The current version of the Zoning Worksheet reflects current understanding that the decks would be considered 'porches' as opposed to 'terraces' and would be included in the total 'building coverage area'. In addition, the area of the decks has been slightly adjusted since the submission of the original application.

(Submitted to the ZBA
for 2/23/22 meeting)

In conclusion, the Applicants are requesting a variance to the Village Code based on hardship due to the substandard lot and the unique circumstances of the property's layout and location. The modest planned improvements are suitable in character and scale to the surrounding residential development and will not adversely impact adjacent properties, not cause any perceivable visual impact from the travel way, nor have a negative impact on Village property values. Please see the attached material in support of this request.

Please contact Susan Jainchill (sjainchill@aspect120.com or 914-274-8544) if you have questions or require additional information. Thank You.

Sincerely,



Susan Y Jainchill, RLA, AIPC
Principal

Village of Ardsley

Mayor
NANCY KABOOLIAN

Trustees
ANDY DIJUSTO, Deputy Mayor
ASHA BENCOSME
STEVEN EDELSTEIN
CRAIG WEITZ



507 Ashford Avenue
Ardsley, New York 10502
(914) 693-1550
Fax (914) 693-3706
www.ardsleyvillage.com

Village Manager
JOSEPH L. CERRETANI

Village Treasurer
LESLIE TILLOTSON

Village Clerk
ANN MARIE ROCCO

January 20, 2022

Ross & Amanda Firsenbaum
38 Western Drive
Ardsley, New York 10502

RE: 38 Western Drive, Property ID #6.50-31-7

Dear Mr. & Mrs. Firsenbaum

I am in receipt of your building permit application #2022-001 dated January 7, 2022 to construct decks, patios, an outdoor kitchen and related site work on the above referenced property.

Section 200-10A of the Code of the Village of Ardsley requires the depth of front yards in the R-1 Residential District to be a minimum of 40 feet. The existing front yard depth is 28.1 feet to the existing house and the proposed front yard depth is 21.5 feet to the proposed deck,

Section 200-10B of the Code of the Village of Ardsley requires the width of side yards in the R-1 Residential District to be a minimum of 30 feet. The existing side yard width on the right exceeds 30 feet to the existing house and the proposed side yard width on the right side is 28.1 feet to the proposed deck.

Section 200-10C of the Code of the Village of Ardsley requires the depth of rear yards in the R-1 Residential District to be a minimum of 40 feet. The existing rear yard depth is 36.8 feet to the existing house and the proposed rear yard depth is 29 feet to the proposed deck.

Section 200-83C of the Code of the Village of Ardsley entitled "Gross Land Coverage" states that the maximum permitted gross land coverage for this 22,216 square foot one-family dwelling lot is 5,610 square feet, subject to Planning Board special permit approval. The existing land coverage is 4,924 square feet, and the proposed land coverage is 6,053 square feet.

Therefore, I must deny you application for this project. You may contact the Zoning Board Secretary if you would like to appeal this decision before the Zoning Board of Appeals.

Yours truly,



Larry J. Tomasso
Building Inspector

Cc: Susan Jainchill, RLA
Zoning Board Secretary
Files: DENIAL LETTERS/Abington38 01-20-22

S 39° 07' 00" W
39.55'

N 14° 24' 00" W

FILED MAP 216.05'
216.13'

S 28° 55' 00" W

FILED MAP 186.51'
186.15'

N 28° 47' 00" E

S 44° 30' 00" E

FILED MAP 104.87'
105.67'

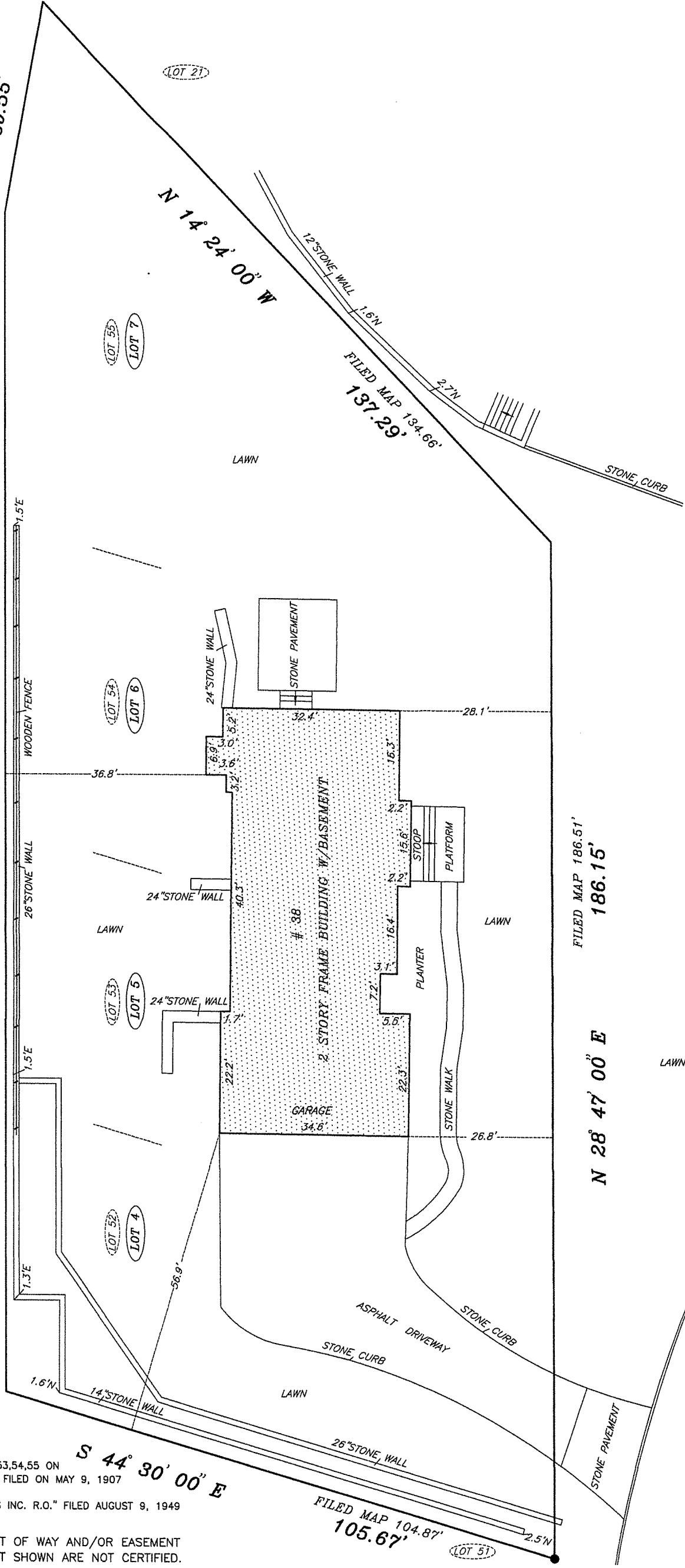

FILED MAP: LOTS NO. 52,53,54,55 ON
"MAP OF ARDSLEY TERRACE" FILED ON MAY 9, 1907
AS MAP NO.1721 AND
MAP OF "TWENTY ONE ACRES INC. R.O." FILED AUGUST 9, 1949

THE EXISTENCE OF RIGHT OF WAY AND/OR EASEMENT
OF RECORD, IF ANY, NOT SHOWN ARE NOT CERTIFIED.

PROPERTY MAP
SCALE 1:20

TITLE NO TONY32590W-16

NOTE:

1. UNAUTHORIZED ALTERATION OR ADDITION TO THIS SURVEY IS A VIOLATION OF SECTION 7209 OF THE NEW YORK STATE EDUCATION LAW.
2. COPIES OF THIS SURVEY MAP NOT BEARING THE LAND SURVEYOR'S INKED SEAL OR EMBOSSED SEAL SHALL NOT BE CONSIDERED TO BE A VALID TRUE COPY.
3. CERTIFICATION INDICATED HEREON SHALL RUN ONLY TO THE PERSON FOR WHOM THE SURVEY IS PREPARED, AND ON HIS BEHALF TO THE TITLE COMPANY, GOVERNMENTAL, AGENCY AND LENDING INSTITUTION LISTED HEREON AND TO THE ASSIGNEES OF THE LENDING INSTITUTION, CERTIFICATIONS ARE NOT TRANSFERABLE TO ADDITIONAL INSTITUTIONS OR SUBSEQUENT OWNERS
4. UNDERGROUND IMPROVEMENTS OR ENCROACHMENTS, IF ANY, ARE NOT SHOWN HEREON.

CERTIFIED TO:

1. FIRST AMERICAN TITLE INSURANCE COMPANY
2. TITLES OF NEW YORK
3. CITI PRIVATE BANK, ISAOA
4. ROSS FIRSENBAUM AND AMANDA FIRSENBAUM

CSE CONSTRUCTION
LAND SURVEYING

61-51 DRY HARBOR RD.
MIDDLE VILLAGE NY 11379
TELEPHONE (347) 981-8435
FAX (347) 730-6691
WWW.CSESUWALA.COM

licensed in NY and NJ

38 WESTERN DRIVE
TOWN OF GREENBURGH
COUNTY OF WESTCHESTER
STATE OF NEW YORK
TAX MAP
SECTION 6.50
BLOCK 31
LOTS 4,5,6,7

DATE: JUNE 16, 2016

CSE 16070

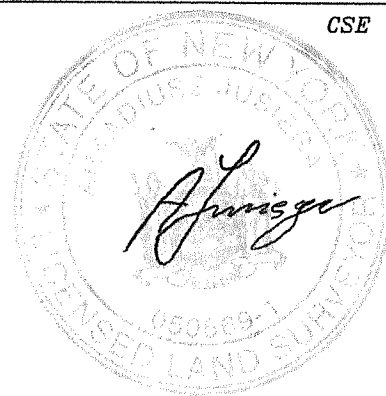

ARKADIUSZ JUSIEGA, PLS.
NEW YORK LICENSE 050569-1

S 39° 07' 00" W
39.55'

LOT 21

N 14° 24' 00" W

FILED MAP 134.66'
137.29'



FILED MAP 216.05'
216.13'

S 28° 55' 00" W

CELLAR EL. 355.70
FF EL. 359.45
EVE EL. 377.92
RIDGE EL. 388.63

2 STORY FRAME BUILDING W/BASEMENT
38

GARAGE EL. 355.70
GARAGE 34.8'

FILED MAP 186.5'
186.15'

N 28° 47' 00" E

WESTERN DRIVE

S 44° 30' 00" E

FILED MAP 104.87'
105.67'

LOT 51

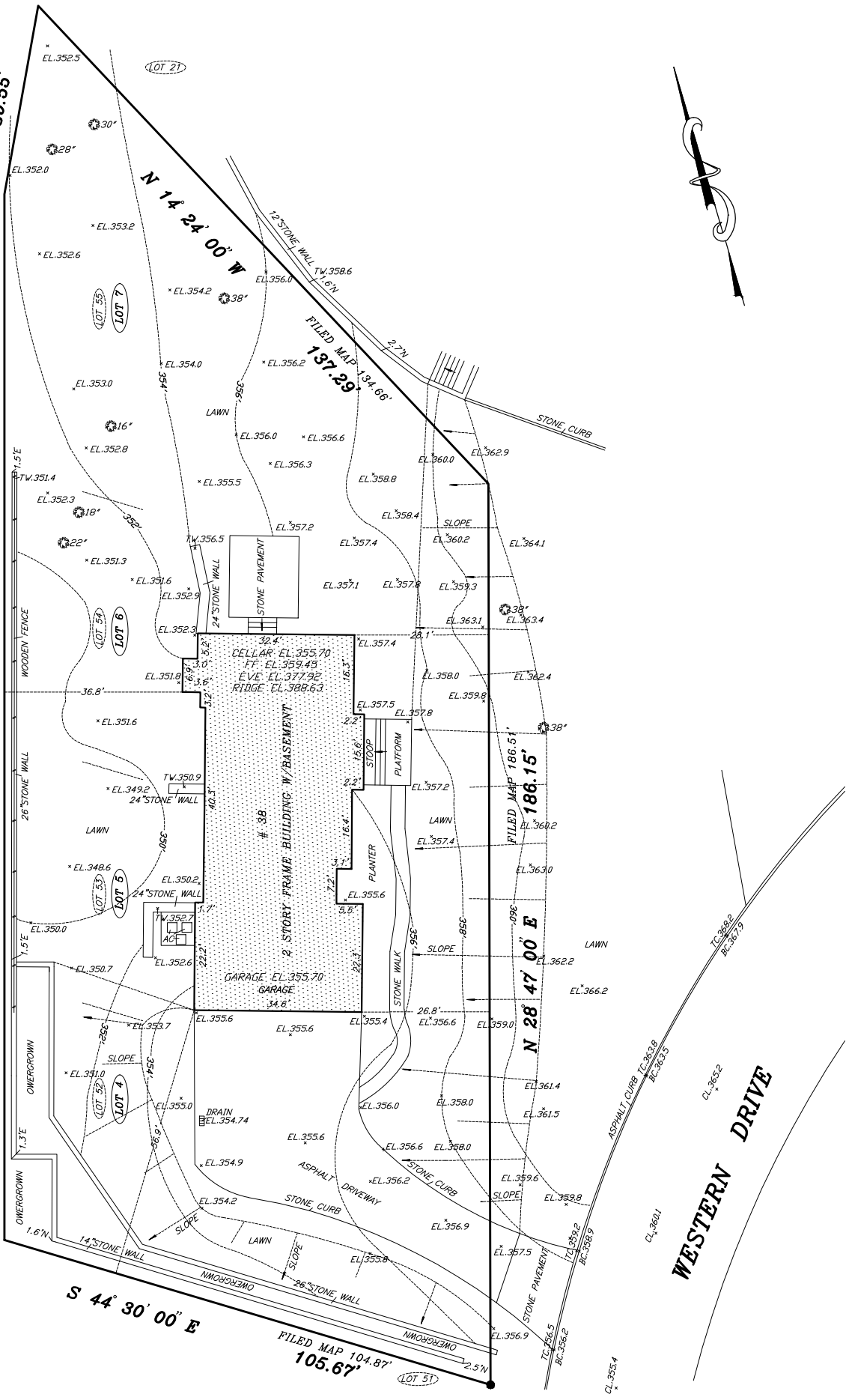

VILLAGE OF ARDSLEY

ZONING WORK SHEET

JOB LOCATION: 38 WESTERN DRIVE

SECTION: 6.50 SUB-SECTION: _____ BLOCK: 31 LOT: 7

OWNER: ROSS AND AMANDA FIRSENBAUM

ARCHITECT: SUSAN JAINCHILL, RLA

LOT AREA: REQUIRED: 40,000 SF
EXISTING: 22,216 SF
PROPOSED: 22,216 SF

STREET FRONTAGE: REQUIRED: 100'
EXISTING: 186.2'
PROPOSED: 186.2'

FRONT SETBACK: REQUIRED: 40'
EXISTING: 26.8'
PROPOSED: 22.5'

SIDE SETBACK: REQUIRED: 30'
EXISTING: 56.9'
PROPOSED: 56.9'

SIDE SETBACK: REQUIRED: 30'
EXISTING: 41.67'
PROPOSED: 30.83'

REAR SETBACK: REQUIRED: 40'
EXISTING: 36.8'
PROPOSED: 29'

BUILDING STORIES: PERMITTED: 2
EXISTING: 2
PROPOSED: 2

BUILDING HEIGHT: MAXIMUM: 30'
EXISTING: 29.18'
PROPOSED: 29.18'
ROOF SLOPE: NA

<u>BUILDING COVERAGE:</u>	MAXIMUM:	<u>12% (2665.92 SF)</u>
	EXISTING:	<u>11.4% (2529.5 SF)</u>
	PROPOSED:	<u>14% 3065.50</u>

<u>FLOOR AREA:</u>	BASIC PERMITTED:	<u>4577.28 SF</u>
	MAXIMUM:	<u>5127.28 SF</u>
	EXISTING:	<u>4078 SF</u>
	PROPOSED:	<u>4078 SF</u>

NOTE: Attach a breakdown of the existing & proposed floor area

<u>LAND COVERAGE:</u>	BASIC PERMITTED:	<u>4765.92 SF</u>
	MAXIMUM:	<u>5610.24 SF</u>
	EXISTING:	<u>4924 SF</u>
	PROPOSED:	<u>6053 SF</u>

NOTE: Attach a breakdown of the existing & proposed land coverage

<u>PARKING:</u>	REQUIRED:	<u>NA</u>
	PROPOSED:	<u>NA</u>

<u>WETLANDS BUFFER:</u>	MINIMUM:	<u>NA</u>
	EXISTING:	<u>NA</u>
	ALLOWED:	<u>NA</u>

<u>STEEP SLOPES:</u>	EXISTING:	<u>NA</u>
	PROPOSED:	<u>NA</u>

IS THE PROPERTY LOCATED IN A FLOODLAIN? no

CERTIFICATION STATEMENT

All dimensions and calculations as set forth on these plans and in this application are certified to be correct.

Signature and seal of registered professional



2/7/2022

Date

02/07/22

Zoning Analysis

		<i>lot area</i>	<i>8% of area in excess of 10,000</i>				<i>allowed</i>	<i>existing</i>	<i>proposed</i>	
		<i>(sf)</i>	<i>(sf)</i>	<i>(sf)</i>	<i>(sf)</i>	<i>(sf)</i>	<i>(sf)</i>	<i>(sf)</i>		
200-83-B Maximum House Size (floor area)										
Basic	3,600 plus 8% of lot area in excess of 10,000 sf	22,216	10,000	12,216	8%	977.28	3,600	4,577.28	4078	4078
Maximum	4,150 plus 10% of lot area in excess of 10,000 sf					977.28	4,150	5,127.28		
200-83-C Gross Land Coverage										
Basic	3,000 plus 12% of lot area in excess of 7,500 sf	22,216	7,500	14,716	12%	1,765.92	3,000	4,765.92	4924	6068
Maximum	3,550 plus 14% of lot area in excess of 7,500 sf	22,216	7,500	14,716	14%	2,060.24	3,550	5,610.24		
200-9 Building Coverage										
R-1 Zone	12% of lot area	22,216			12%		2,665.92	2529.5	3065.5	
							12.0%	11.4%	14.0%	

Zoning Worksheet Attachment
Firsenbaum, 38 Western Drive, Ardsley, NY 10502

(Submitted to the ZBA
for 2/23/22 meeting)

02/07/22

Breakdown of Existing and Proposed Land Coverage

	<i>existing</i>	<i>proposed</i>
	<i>(sf)</i>	<i>(sf)</i>
Property Size	22,216	22,216
House	2529.5	2529.5
Decks	0	536
Building Coverage	2529.5	3065.5
Driveway and Utility Pads	1800	1800
Walks and Stairs	332.5	332.5
Patio and Retaining Walls	262	870
Other Land Coverage	2394.5	3002.5
Gross Land Coverage	4924	6068



(Submitted to the ZBA
for 2/23/22 meeting)



Greenburgh, NY

1 inch = 71 Feet



www.cai-tech.com

January 26, 2022

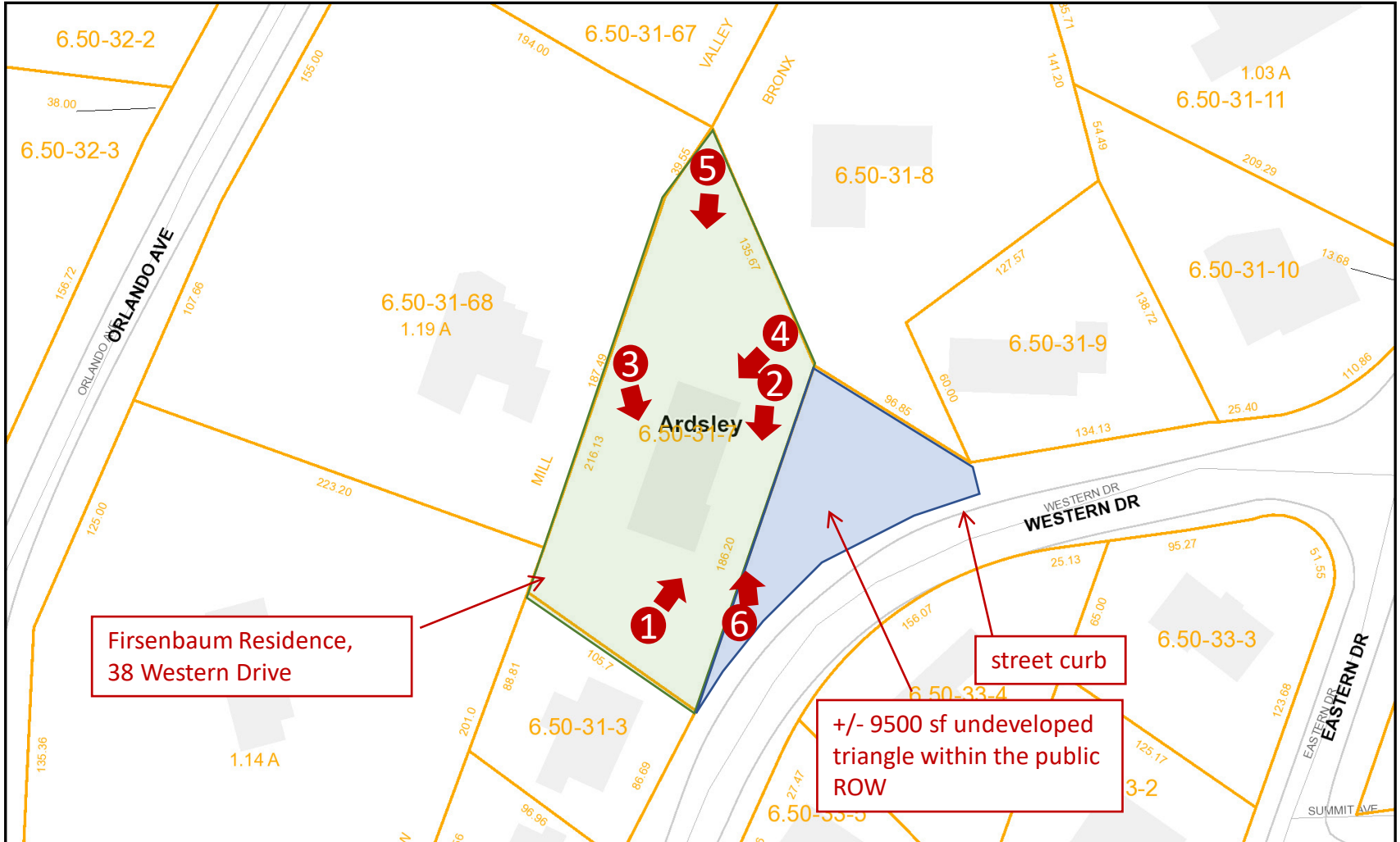

Data displayed on this map is for informational purposes only. Most layers originate from 3rd parties and cannot be verified by the Tax Assessor's office or CAI Technologies. Please consult with department or organization where data originates in order to verify accuracy. Any questions, call Town Assessor's Office: 1-914-989-1520.



1



2

3



Rear Yard/ Basement Doors:
Dashed lines indicate extents
of proposed wood decking at
door sill level

4



Side Yard:
Dashed lines indicate extents
of proposed wood deck at
door sill level



View from northernmost
point on the property to the
north side of the house

5



View from right-of-way near
driveway.

6

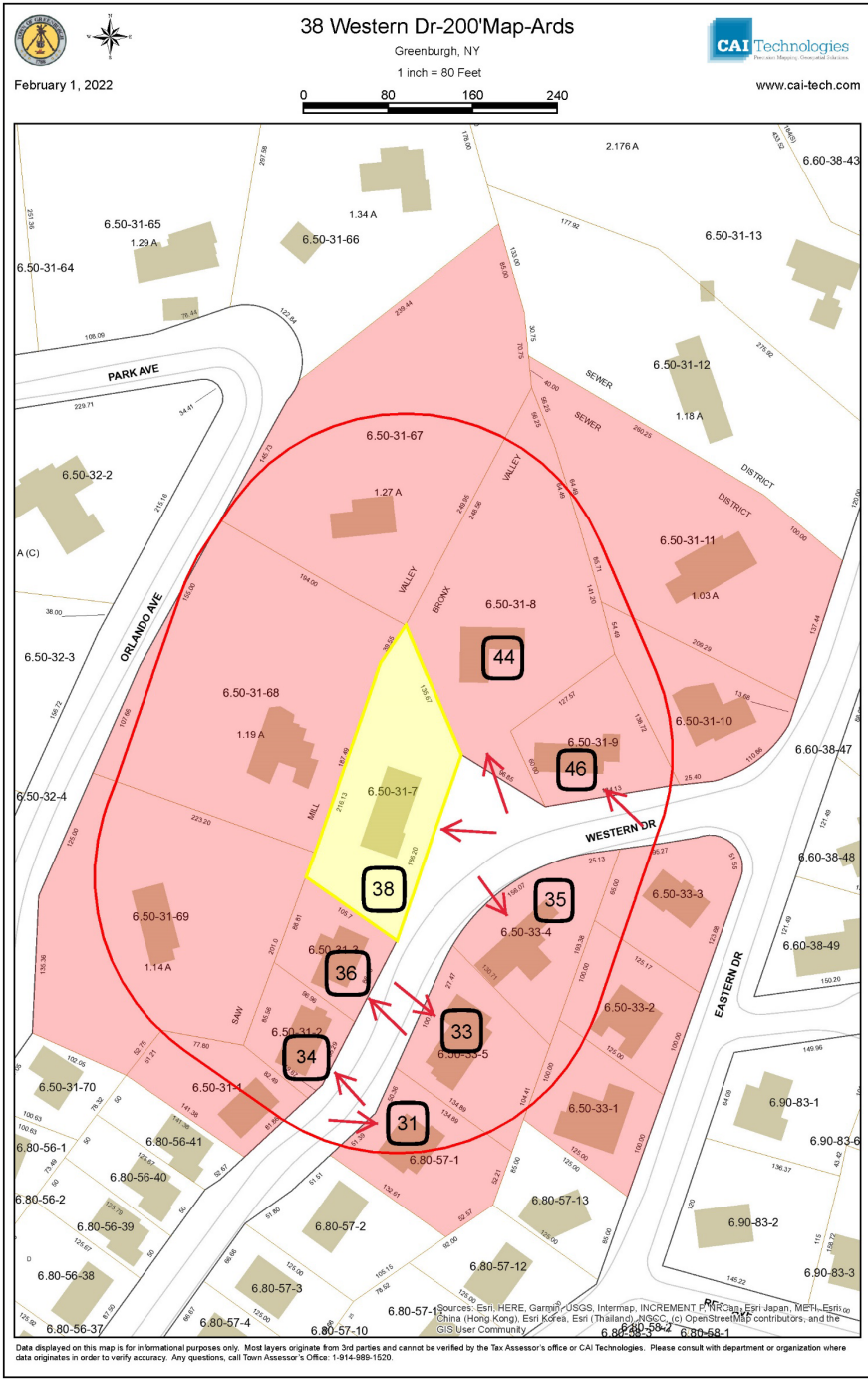

(Submitted to the ZBA
for 2/23/22 meeting)



31 Western Dr.



33 Western Dr.



35 Western Dr.



46 Western Dr.

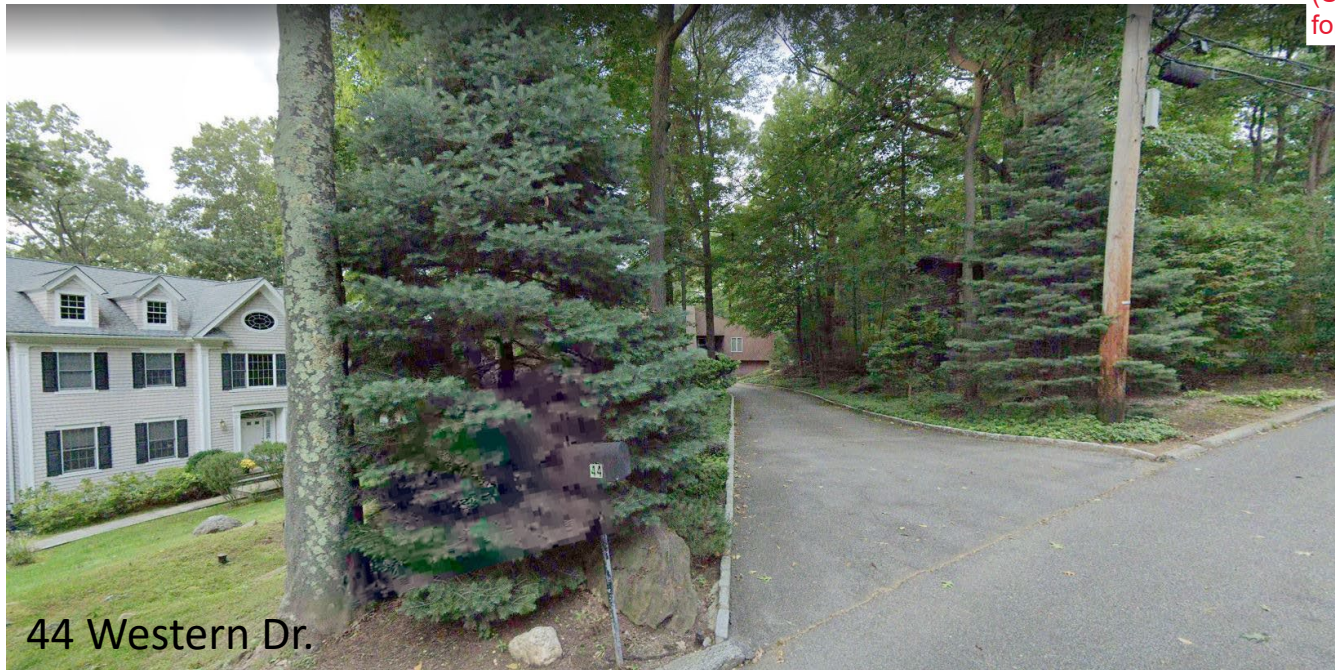

44 Western Dr.



38 Western Dr.

Google

(Submitted to the ZBA
for 2/23/22 meeting)



36 Western Dr.



34 Western Dr.

OVERALL PLAN

SCALE: 1" = 30'-0"

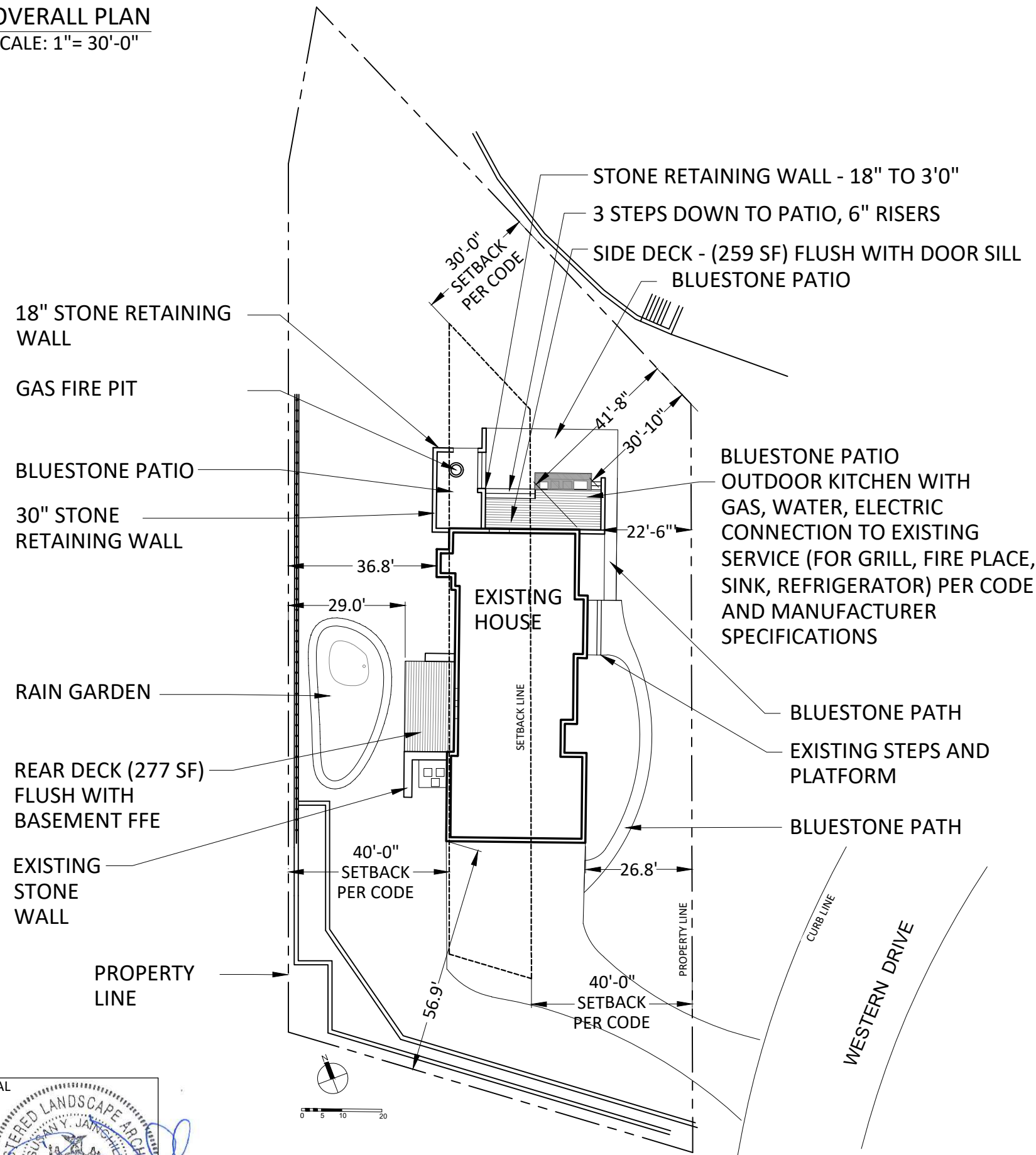

SIDE DECK & PATIO, WALLS LAYOUT PLAN

SCALE: 1" = 10'-0"

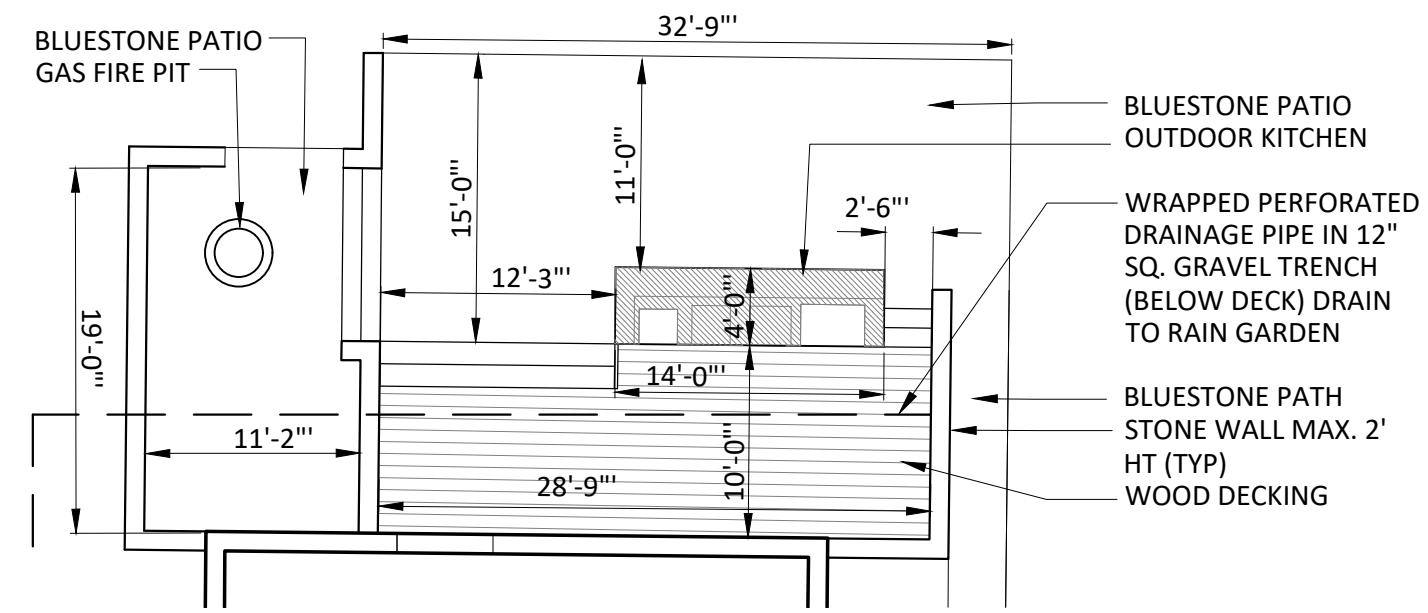

BACK DECK & RAIN GARDEN LAYOPUT PLAN

SCALE: 1" = 10'-0"

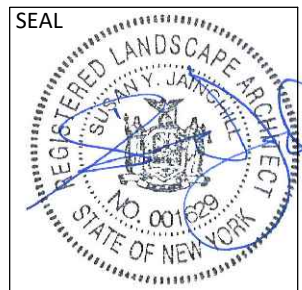
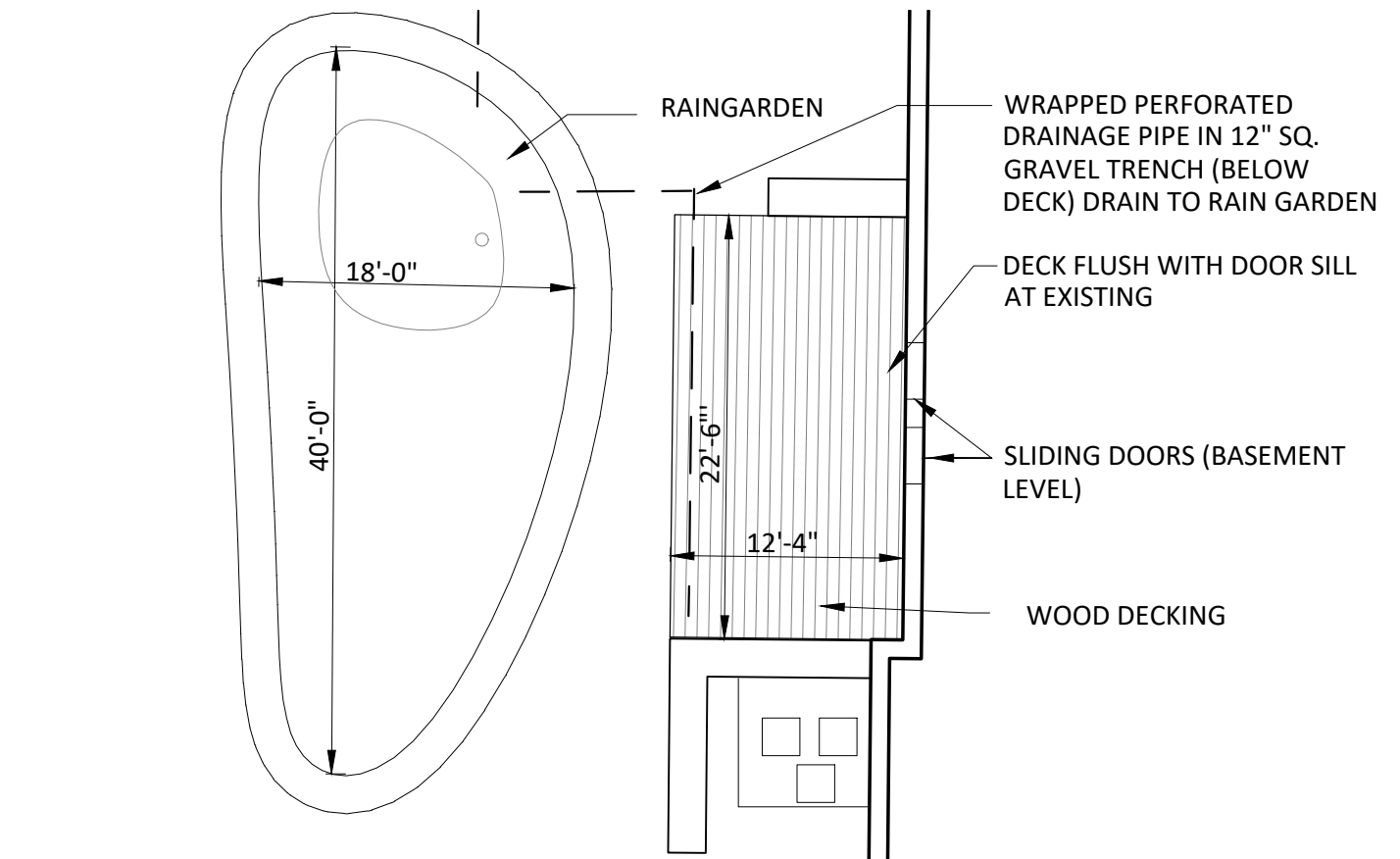

ASPECT 120 LANDSCAPE ARCHITECTURE P.C.
90 NORTH BROADWAY, SUITE 223, IRVINGTON, NY 10533
WWW.ASPECT 120.COM / PHONE: (914) 274-8544



PROJECT:
FIRSENBAUM RESIDENCE
38 WESTERN DRIVE, ARDSLEY, NY 10502

DRAWING TITLE:
SITE IMPROVEMENT PLANS

REVISED
(2) 2/07/22 ZBA SUBMITTAL
(3) 4/13/22 DRAINAGE PIPE ADDED

SCALE: AS NOTED
DATE: 12/29/2021
REVISED: (1) 1/14/22

SK-1

SIDE DECK PLAN

SCALE: 1/4" = 1'-0"

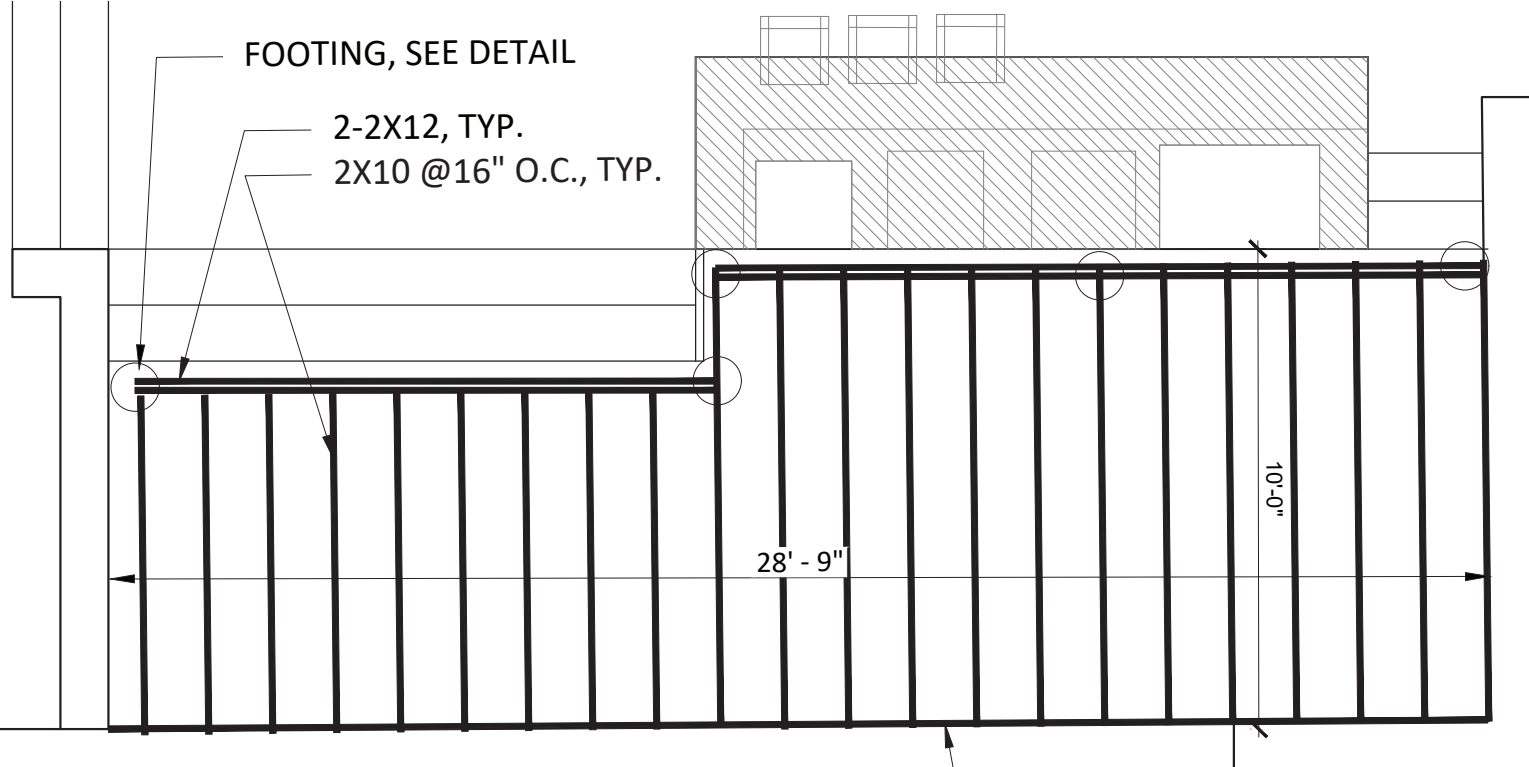

BACK DECK PLAN

SCALE: 1/4" = 1'-0"

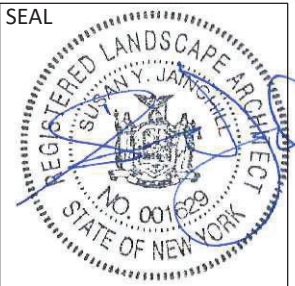
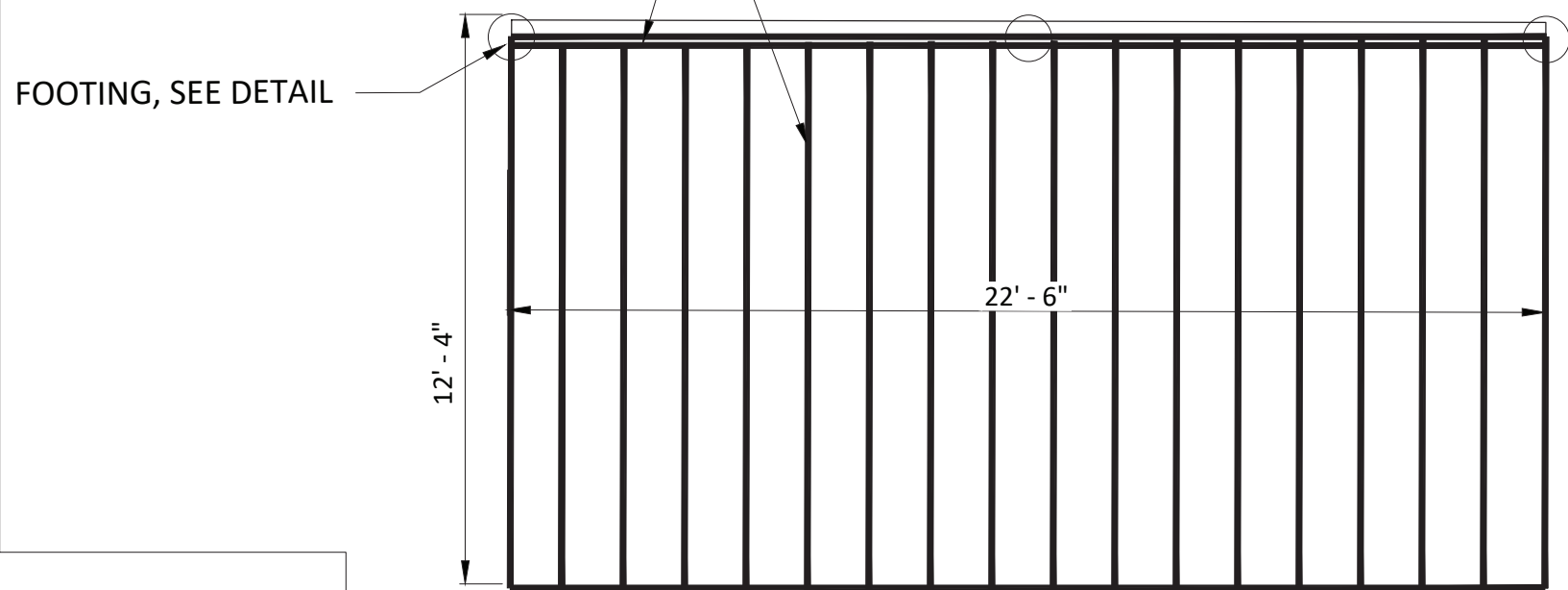

ASPECT 120 LANDSCAPE ARCHITECTURE P.C.
90 NORTH BROADWAY, SUITE 223, IRVINGTON, NY 10533
WWW.ASPECT120.COM / PHONE: (914) 274-8544

PROJECT: **FIRSENBAUM RESIDENCE**
38 WESTERN DRIVE, ARDSLEY, NY 10502

FOOTING DETAIL

SCALE 1/2" = 1'

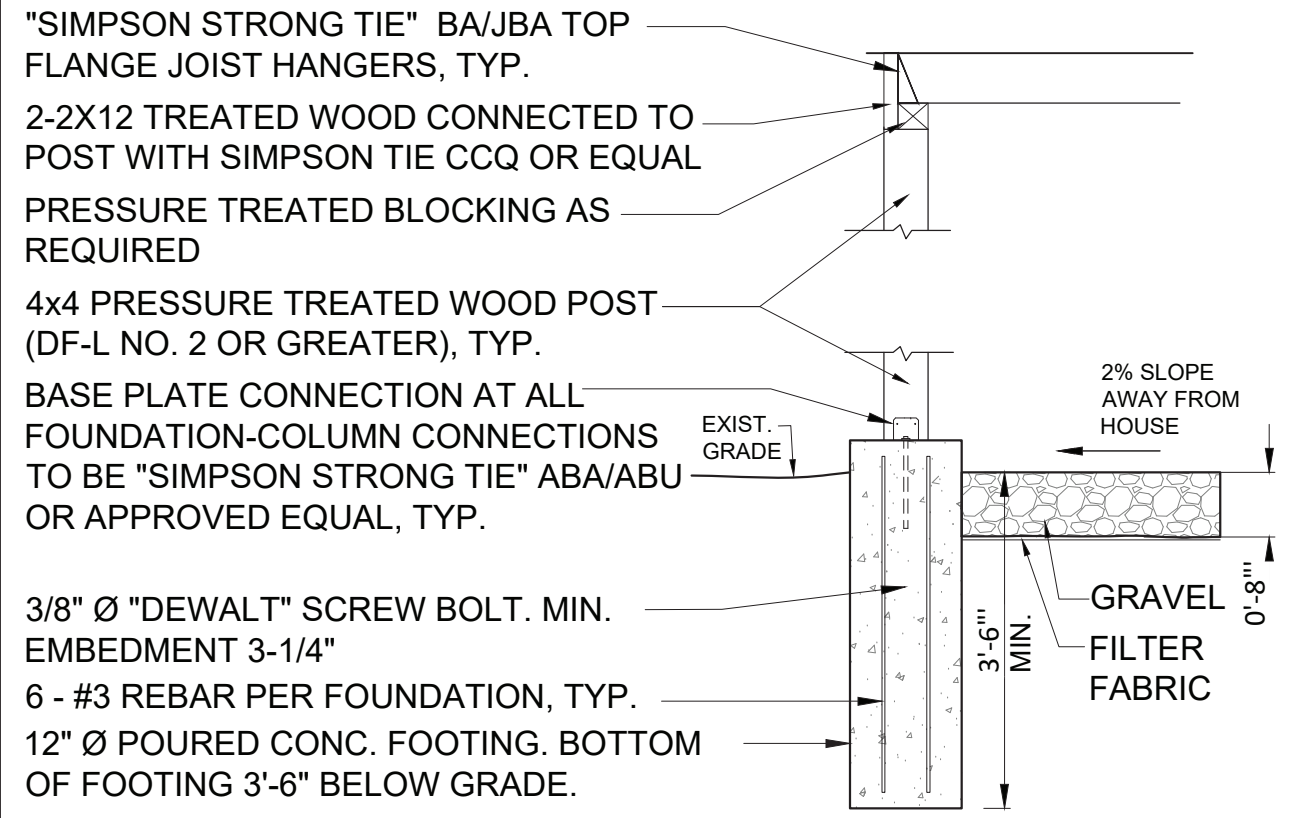

ALTERNATE FOOTING DETAIL

SCALE 1/2" = 1'

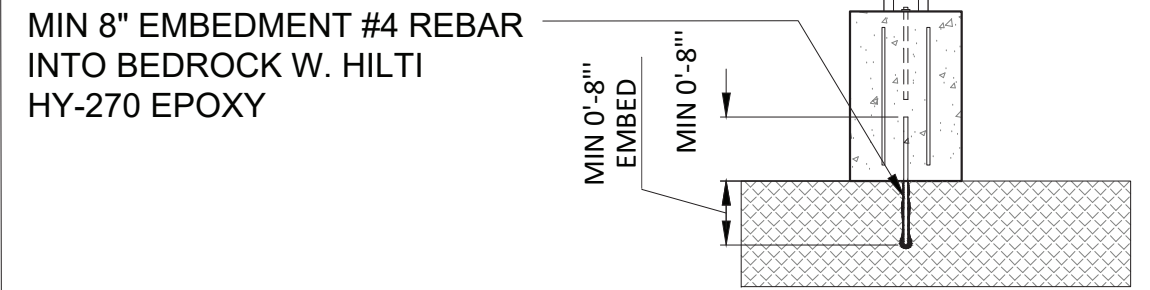

DECK ATTACHMENT DETAIL TO EXIST. BLDG.

SCALE 1/2" = 1'

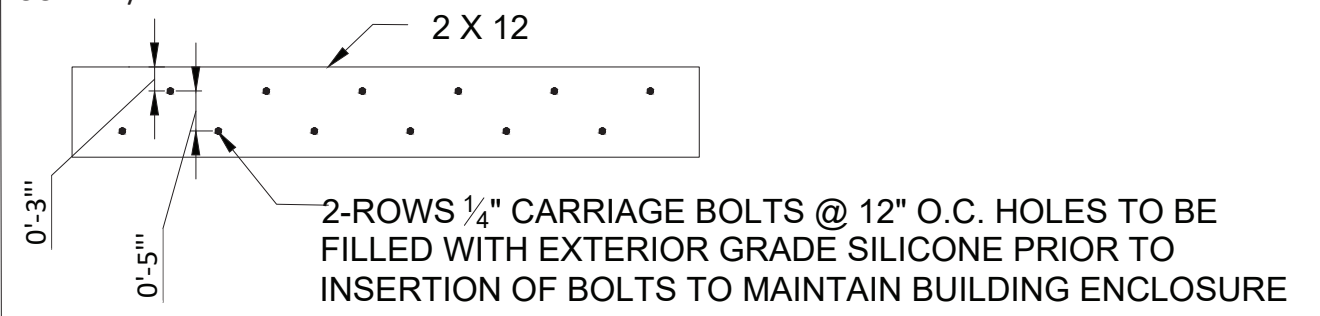

DRAWING TITLE: **DECK DETAILS**

SCALE: AS NOTED
DATE: 12/29/2021
REVISED: 1/14/2021

SK-2

RAINGARDEN PLANTING PLAN

SCALE: 1" = 10'-0"

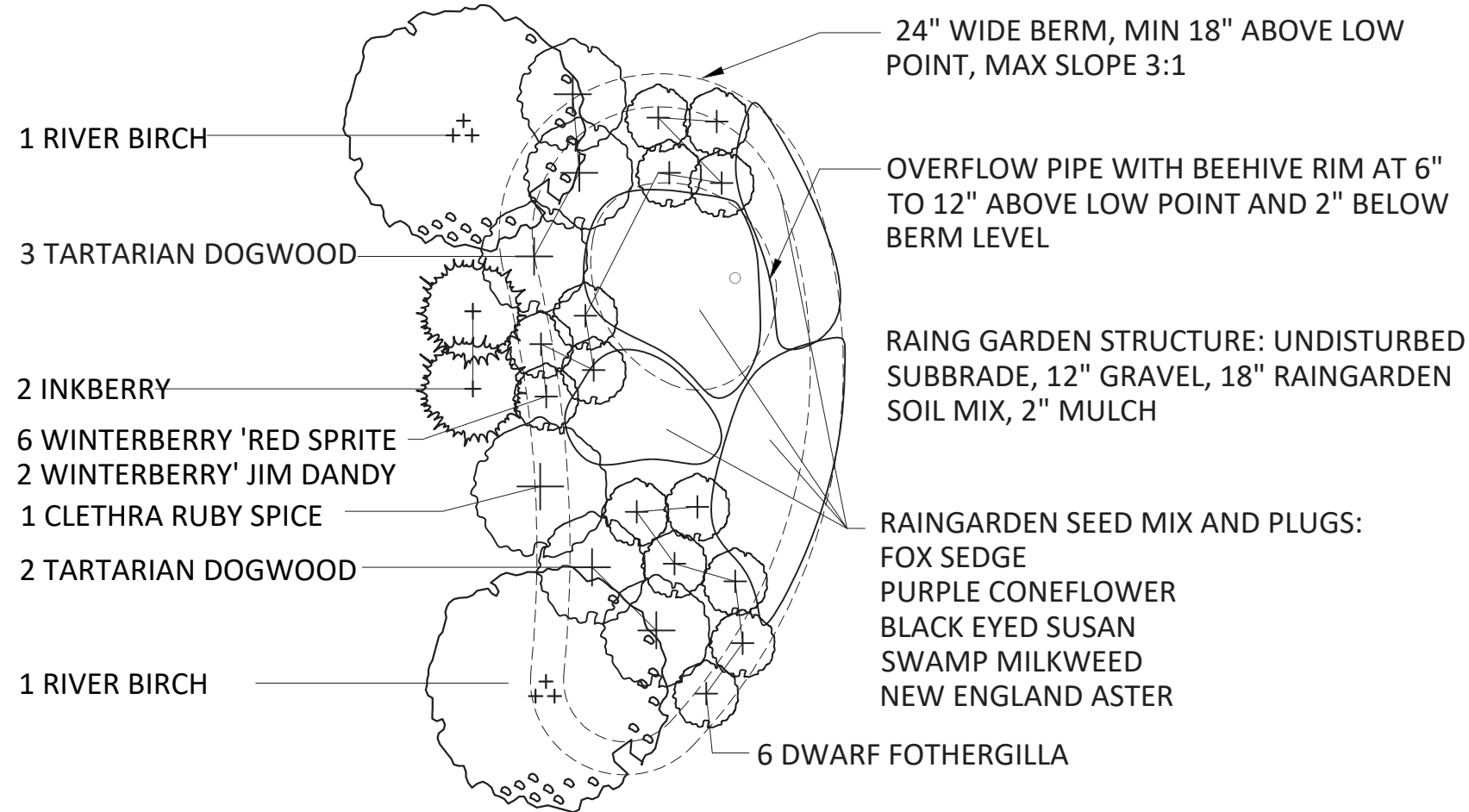

RETAINING WALL DETAIL

SCALE: 1/4" = 1'-0"

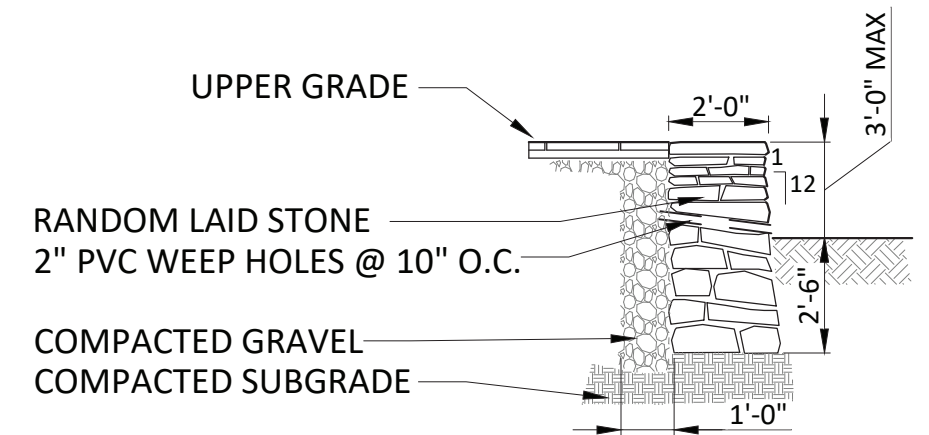

BLUESTONE PATIO PAVING DETAIL

SCALE: 3/4" = 1'-0"

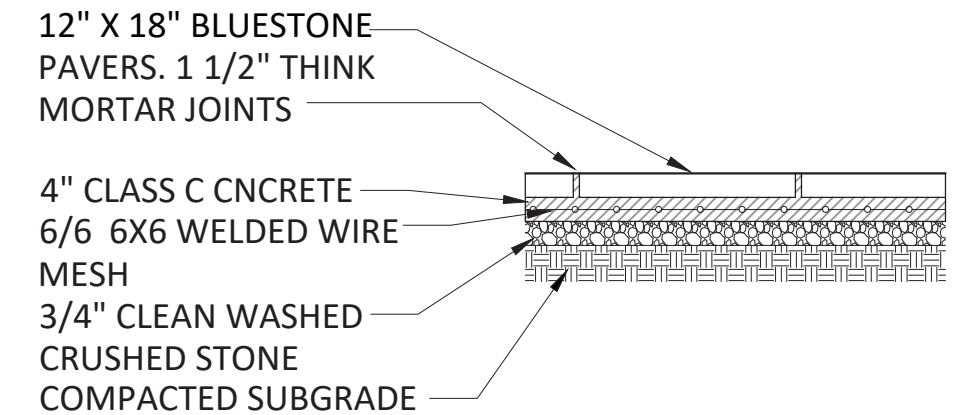

DECK/ HOUSE CONNECTION DETAIL

SCALE 1/2" = 1'-0"

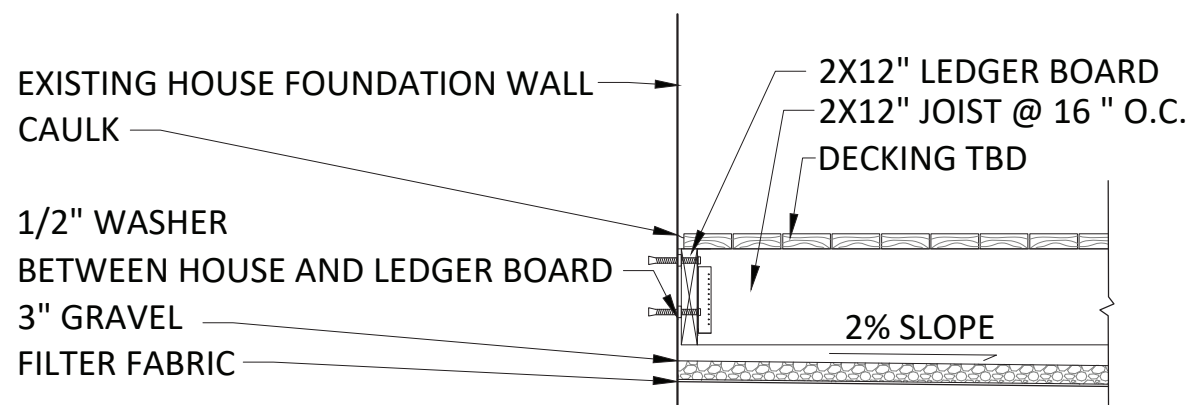

RAINGARDEN DETAIL

SCALE 1/4" = 1'-0"

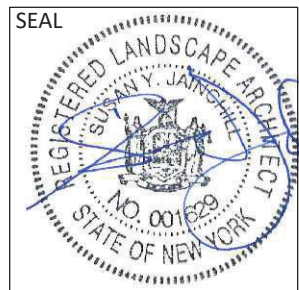
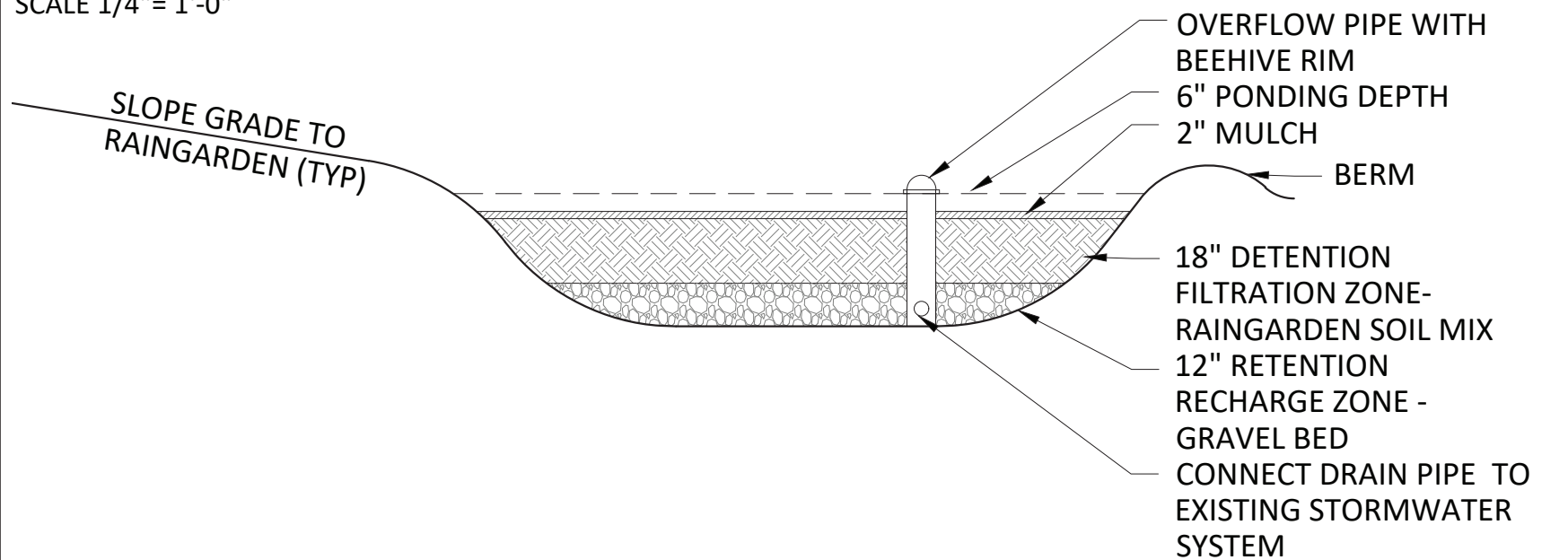

ASPECT 120 LANDSCAPE ARCHITECTURE P.C.
 90 NORTH BROADWAY, SUITE 223, IRVINGTON, NY 10533
 WWW.ASPECT 120.COM / PHONE: (914) 274-8544



PROJECT: **FIRSENBAUM RESIDENCE**
 38 WESTERN DRIVE, ARDSLEY, NY 10502

DRAWING TITLE: **SITE DETAIL**

SCALE: AS NOTED
 DATE: 12/29/2021
 REVISED: 1/14/2021

SK-3

GENERAL NOTES:

- 1) NOTES, TYPICAL DETAILS AND SCHEDULES APPLY TO ALL STRUCTURAL WORK UNLESS OTHERWISE NOTED. FOR CONDITIONS NOT SPECIFICALLY SHOWN, PROVIDE DETAILS OF A SIMILARLY NATURE, VERIFY APPLICABILITY BY SUBMITTING SHOP DRAWINGS FOR REVIEW.
- 2) IF THERE IS A DISCREPANCY BETWEEN DRAWINGS IT IS THE CONTRACTOR'S RESPONSIBILITY TO NOTIFY THE ENGINEER PRIOR TO PERFORMING WORK.
- 3) DO NOT SCALE DRAWINGS TO OBTAIN DIMENSIONAL INFORMATION.
- 4) THESE DRAWINGS DO NOT DEFINE SCOPE OF CONTRACTS.
- 5) AT ALL TIMES THE CONTRACTOR SHALL BE SOLELY RESPONSIBLE FOR THE CONDITIONS OF THE JOBSITE, INCLUDING SAFETY OF PERSONS AND PROPERTY. THE ARCHITECT'S OR ENGINEER'S PRESENCE OR REVIEW OF WORK DOES NOT INCLUDE THE ADEQUACY OF THE CONTRACTOR'S MEANS OR METHODS OF CONSTRUCTION.
- 6) SHORING, BRACING AND PROTECTION OF EXISTING AND ADJACENT STRUCTURES DURING CONSTRUCTION IS THE SOLE RESPONSIBILITY OF THE CONTRACTOR. PROTECT AND MAINTAIN THE INTEGRITY OF ADJACENT STREETS, BUILDINGS AND STRUCTURES.
- 7) ALL EXISTING DIMENSIONS AND LOCATIONS OF EXISTING STRUCTURES ON DRAWINGS SHALL BE VERIFIED BY FIELD MEASUREMENTS. ANY DISCREPANCIES SHALL BE REPORTED TO THE ENGINEER.
- 8) DRAWINGS HAVE BEEN PREPARED BASED ON AVAILABLE KNOWLEDGE OF EXISTING CONDITIONS. IF, DURING DEMOLITION, EXCAVATION, OR CONSTRUCTION ACTUAL CONDITIONS ARE DISCOVERED TO DIFFER FROM THOSE INDICATED ON DRAWINGS, ENGINEER SHALL BE NOTIFIED IMMEDIATELY.

FOUNDATION NOTES:

- 1) FOOTINGS SHALL BEAR ON FIRM, UNDISTURBED SOIL AT A MINIMUM OF 3'-6" BELOW FINISHED GRADE. ALL FOOTINGS SHALL BE FORMED.
- 2) PROVIDE WATER STOPS IN ALL VERTICAL CONSTRUCTION JOINTS.
- 3) SLABS ON GRADE SHALL BE PLACED ON SELECT FILL COMPACTED TO 90 PERCENT MODIFIED PROCTOR MAXIMUM DRY DENSITY (ASTM D1557) AND HAVE A VAPOR BARRIER OF 6MIL POLYETHYLENE FILM WITH EDGES LAPPED 6" OVER A 4" GRAVEL BED.

WOOD FRAMING NOTES:

- 1) ALL WOOD TO BE DF-L NO. 1 OR EQ/GREATER, U.O.N.
- 2) ALL CONSTRUCTION SHALL BE IN ACCORDANCE WITH THE 2020 NYS RESIDENTIAL BUILDING CODE
- 3) ALL CONNECTIONS TO BE MADE PER MANUFACTURER'S INSTRUCTIONS, RECOMMENDATIONS AND FASTENING REQUIREMENTS.
- 4) LVL'S SHALL HAVE A MINIMUM OF 2 ROWS OF 16D NAILS 12" OC FOR BEAMS LESS THAN 12", 3 ROWS FOR GREATER THAN 12"
- 5) APPROPRIATE SIMPSON STRONG-TIE CONNECTORS TO BE INSTALLED AND USED FOR THEIR INTENDED PURPOSE
- 6) HURRICANE TIES TO BE MIN 18-GA LTS
- 7) COLUMNS CAPS TO BE CC/ECC/ECCU U.O.N.
- 8) TOP FLANGE JOIST HANGERS JB/JBA TO BE USED FOR ALL ASYMMETRIC LOADED BEAMS, FACE MOUNTED JOIST HANGERS LU28/LUS28 TO BE USED FOR SYMMETRIC LOADED BEAMS ONLY.
- 9) ALL WOOD EXPOSED TO WEATHER SHALL BE PRESSURE TREATED KILN-DRIED AND PAINTED. IF WOOD IS NOT KILN-DRIED, ALLOW 2-4 MONTHS TO DRY AND THEN PAINT. PAINT SHALL BE EXTERIOR GRADE AND APPLIED WITH PRIMER OR PER MANUFACTURER'S INSTRUCTIONS (MINIMUM 2 COATS)

CONCRETE NOTES:

- 1) CONCRETE WORK SHALL CONFORM TO ACI-318. IN CASE OF CONFLICT, THE NEW YORK STATE BUILDING CODE SHALL TAKE PRECEDENCE
- 2) ALL FOOTINGS FOUNDATION WALLS, FRAMED SLABS SHALL BE CONTROLLED AIR ENTRAINED CONCRETE HAVING A MINIMUM ULTIMATE COMPRESSIVE STRENGTH OF 5000-PSI IN 28 DAYS, ASTM TYPE 1 WITH 4" SLUMP, AND HAVE PROPERTIES TO RESIST SEVER WEATHERING POTENTIAL.
- 3) ALL REINFORCING SHALL BE A MINIMUM OF GRADE 60
- 4) ALL DOWELS TO BE HOT-DIP GALVANIZED WITH NUT AND WASHER TO FIT ALONG TOP OF FOUNDATION WHERE SILL PLATES ARE TO BE ANCHORED, EXTEND 16" INTO CONCRETE BELOW, AND WITH HOOKS MINIMUM OF 4"
- 5) REINFORCING CONCRETE SHALL HAVE A MINIMUM CLEAR COVER AS FOLLOWS:
 - a. CONCRETE POURED AGAINST EARTH - 3"
 - b. CONCRETE EXPOSED TO EARTH OR WEATHER
 - i. #5 OR SMALLER - 1½"
 - ii. #6 OR LARGER - 2"
 - c. CONCRETE NOT EXPOSED TO WEATHER OR IN CONTACT WITH GROUND
 - i. COLUMNS (TIES & MAIN REINFORCING) - 1½"
 - ii. SLABS, WALLS, JOISTS #14 OR #18 BARS - 1½"
 - iii. #11 OR SMALLER - ¾"
 - iv. BEAMS (STIRRUPS AND MAIN REINFORCING) - 1½"
 - d. CLEAR COVER SHALL BE CLEARLY SHOWN ON ALL REBAR DETAIL DRAWINGS
- 6) ALL REINFORCING SHALL BE SECURELY HELD IN POSITION WHILE PLACING CONCRETE. IF NECESSARY, ADDITIONAL BARS SHALL BE PROVIDED BY THE CONTRACTOR TO FURNISH SUPPORT
- 7) LOCATION OF ALL CONSTRUCTION JOINTS NOT SHOWN ON DRAWINGS SHALL BE SUBMITTED TO ENGINEER FOR APPROVAL PRIOR TO DETAILING OF REINFORCING. ALL CONSTRUCTION JOINTS TO BE CLEARLY SHOWN ON REBAR DETAIL DRAWINGS. ENGINEER MAY REQUIRE ADDITIONAL REINFORCING AT CONSTRUCTION JOINTS.
- 8) COLD WEATHER CONCRETE CONSTRUCTION SHALL BE IN COMPLIANCE WITH ACI 318.

PLANTING NOTES:

- 1) THE CONTRACTOR SHALL LOCATE AND VERIFY ALL UNDERGROUND UTILITIES PRIOR TO ANY LAWN WORK OR TREE AND SHRUB PLANTING AND SHALL IMMEDIATELY REPORT ANY CONFLICTS TO THE PROJECT SITE ENGINEER.
- 2) THE CONTRACTOR SHALL SUPPLY ALL PLANT MATERIAL IN QUANTITIES SUFFICIENT TO COMPLETE THE PLANTING SHOWN ON THE DRAWING. NO PLANT OR CULTIVAR SUBSTITUTIONS WILL BE ACCEPTABLE WITHOUT APPROVAL OF THE LANDSCAPE ARCHITECT
- 3) OWNER'S REPRESENTATIVE SHALL INSPECT PLANT MATERIAL FOR ACCEPTANCE PRIOR TO PLANTING.
- 4) SPECIAL ATTENTION WILL BE GIVEN TO PROTECTION OF ROOT ZONES OF EXISTING TREES WHEN LOCATING NEW PLANT MATERIALS. LOCATION OF NEW PLANT MATERIAL SHALL BE STAKED OR SET OUT BY CONTRACTOR AND APPROVED BY LANDSCAPE ARCHITECT PRIOR TO PLANTING. SPECIAL ATTENTION WILL BE GIVEN TO PROTECTION OF ROOT ZONES OF EXISTING TREES WHEN LOCATING NEW PLANT MATERIALS .
- 5) THE CONTRACTOR SHALL REMOVE ALL PLASTIC MATERIAL FROM AROUND THE ROOT BALLS OF THE PLANTS AFTER POSITIONING IN THE PLANT PITS. REMOVE BURLAP, ROPE, AND WIRE FROM AROUND THE TRUNK SUFFICIENTLY SO THAT NO BURLAP, ROPE OR WIRE WILL BE EXPOSED AFTER BACKFILLING.
- 6) CONTRACTOR SHALL EXERCISE EXTREME CARE IN WORKING IN AREA OF EXISTING TREES. EXISTING PLANTS TO REMAIN AND BE PROTECTED, WHICH ARE INJURED OR DESTROYED DURING CONSTRUCTION SHALL BE REPLACED BY CONTRACTOR WITH PLANTS OF EQUAL SIZE AND SPECIES AT NO COST TO THE OWNER.
- 7) ALL AREAS THAT HAVE BEEN DISTURBED BY PLANTING ACTIVITY SHALL BE RESTORED TO A NEAT CONDITION. AREAS WITH BARE SOIL SHALL BE TOPSOILED AND SEEDED WITH NATIVE SPECIES SEED MIX
- 8) THE CONTRACTOR SHALL WATER TREES, SHRUBS AND GROUND COVER TWICE DURING THE FIRST 24 HOURS AND AS NEEDED THROUGHOUT THE FIRST GROWING SEASON.

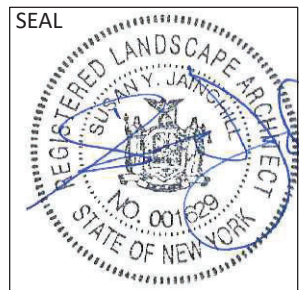

ASPECT 120 LANDSCAPE ARCHITECTURE P.C.
90 NORTH BROADWAY, SUITE 223, IRVINGTON, NY 10533
WWW.ASPECT120.COM / PHONE: (914) 274-8544



PROJECT:

FIRSENBAUM RESIDENCE
38 WESTERN DRIVE, ARDSLEY, NY 10502

DRAWING TITLE:

NOTES

SCALE: NA
DATE: 12/29/2021
REVISED: 1/14/2021

SK-4

LEGEND

 Proposed plants for screening from adjacent property.

PLANT LIST

KEY	QNT	BOTANICAL NAME	COMMON NAME	SIZE	SPACING
DECIDUOUS TREES					
CC	1	CERCIS CANADENSIS 'ACE OF HEARTS'	CANADIAN REDBUD 'ACE OF HEARTS'	6'-8' HT	AS SHOWN
EVERGREEN TREES					
IO	2	ILEX OPACA	AMERICAN HOLLY	6'-8' HT	AS SHOWN
PA	2	PICEA ABIES	NORWAY SPRUCE	6'-8' HT	AS SHOWN
PG	3	PICEA GLAUCA	WHITE SPRUCE	6'-8' HT	AS SHOWN
DECIDUOUS SHRUBS					
HI	1	HAMAMELIS X INTERMEDIA	ARNOLD PROMISE WITCH HAZEL	#7 CONT	AS SHOWN

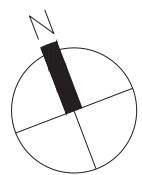
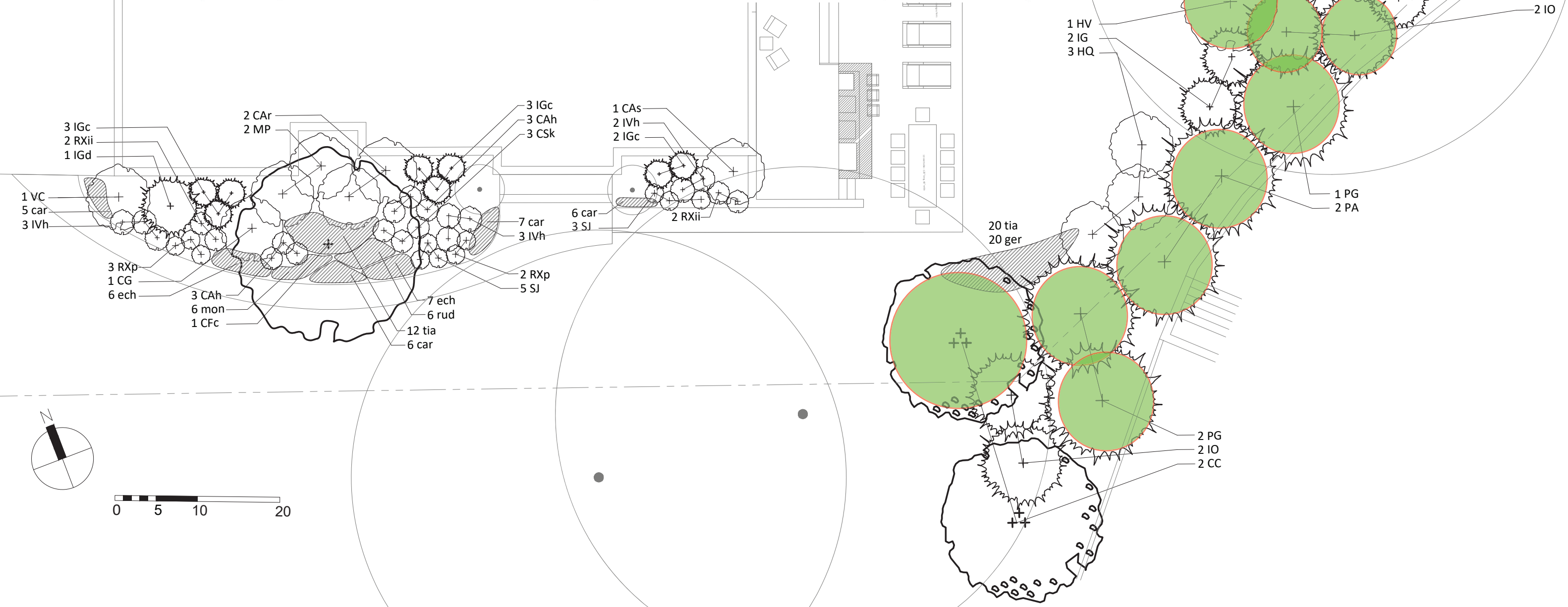

SEAL

ASPECT 120 LANDSCAPE ARCHITECTURE P.C.
90 NORTH BROADWAY, SUITE 223, IRVINGTON, NY 10533
WWW.ASPECT120.COM / PHONE: (914) 274-8544

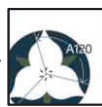

PROJECT:
FIRSENBAUM RESIDENCE
38 WESTERN DRIVE, ARDSLEY, NY

DRAWING TITLE:
PLANTING PLAN - FOUNDATION AND SCREENING

SCALE:
DATE: 3/20/2022
REV: 4/11/2022

SK-5